

Desktop foiling and lamination from one compact unit

Easily add decorative creativity to printed sheets with ColorFlare

SEE FULL SYSTEM SPECIFICATION OVERLEAF

Laminates | Foils | Holographics

- Foiling, lamination and flaring effects are possible with this single desktop solution
- Class leading affordability
- Uses 3" (77mm) core rolls providing more cost effective production
- No need to have traditional UV coating for diverse effects
- Simple in-house process - no expensive blocks or dies required



HEATED TOP & BOTTOM ROLLERS



ADJUSTABLE PRESSURE 50kg/m²



HOUSEHOLD 220 ~ 240V



W = 580mm
L = 500mm
H = 430mm

TOP FEATURES

- Ideal entry level machine for:
 - gloss & matt lamination
 - over-printable soft touch lamination
 - gloss & matt lamination
 - metallic & coloured foiling
 - holographic effect films
- Handles SRA3 + media
- Easy continuous feed
- Adjustable pressures for different applications
- Tension control
- De-curling bar for flatter sheets
- Heated top and bottom rollers designed to apply overall heat to substrates - avoids silvering of laminates
- Auto stop function to save foil waste
- Cutting knife for end of job trimming
- Air cooling offers a wider media range
- Quiet operation
- Uses conventional household 220-240V power supply

TYPICAL APPLICATIONS

- Packaging
- Menus
- Swing tickets
- Presentation folders
- Book covers
- Point-of-sale
- Business cards
- Wedding stationery
- Photo albums
- Certificates
- Labels
- Gift vouchers



Air cooling system



Easy to use controls



Tension control

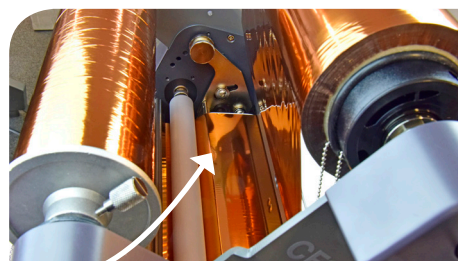

De-curl bar



Adjustable pressure



ColorFlare printer compatibility guide*



Intec ColorFlare has been developed to work with the Intec ColorSplash series and is compatible with the world's top digital printer manufacturers.



KONICA MINOLTA



*Call for confirmation of model compatibility

Technical specifications*	
Laminating speed	1.3m/min
Base substrate thickness	Lamination: 80gm ² to 350gm ² Foiling: 120gm ² to 350gm ²
Paper Size	Maximum: 330mm to 500mm Minimum: 180mm x 230mm
Warm-up time	5 minutes
Heating system	Infrared heater
Laminating temperature	Top roller: maximum 150°C Bottom roller: maximum 100°C
Temperature control	Control panel push button
Speed control	Control panel push button
Display system	LCD display
Roller pressure	Adjustable manual handle
Film core size	77mm (3")
Air cooling system	Dual fan system
Temperature sensing method	Internal thermo-couple
Rear trimming knife	Blade for end of job trimming
Power requirement	AC 220~240V, 50/60Hz, 7A
Power consumption	1.5kw

CF350 footprint

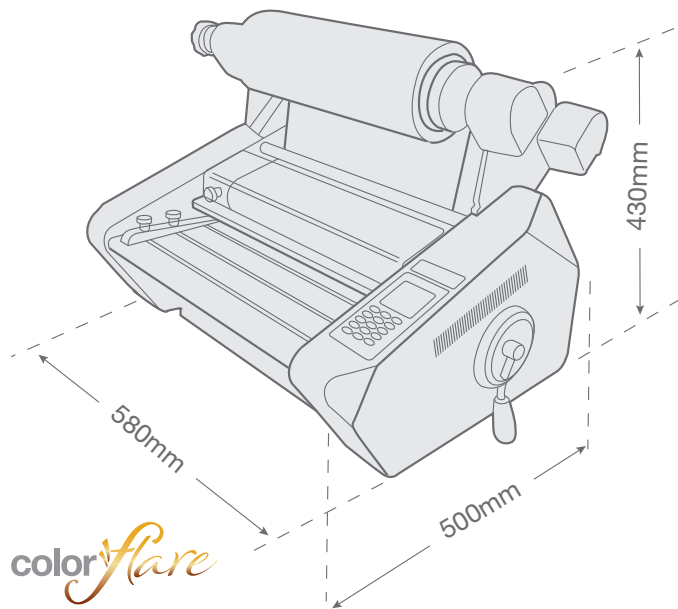

Dimensions W x L x H	Weight (kgs)
580 x 500 x 430mm	35kg

A growing range of consumables...*

Lamination films

Various finishes including: gloss, matt and soft touch, for litho and digital print. Digital laminates are corona-treated for subsequent over-printing.

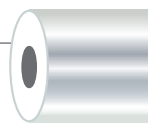

Foil flaring films

Available in a growing range of colours including: gold, silver, red, green, blue, violet, black, white and clear gloss. All can be applied direct to print.

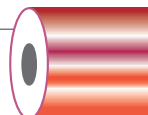

Holographic flaring films

Such as: sparkle, milky way, crystal, carbon fibre... Perfect for adding premium effects to print.

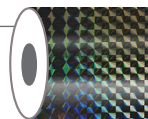

*See consumables support sheet.

Speed chart

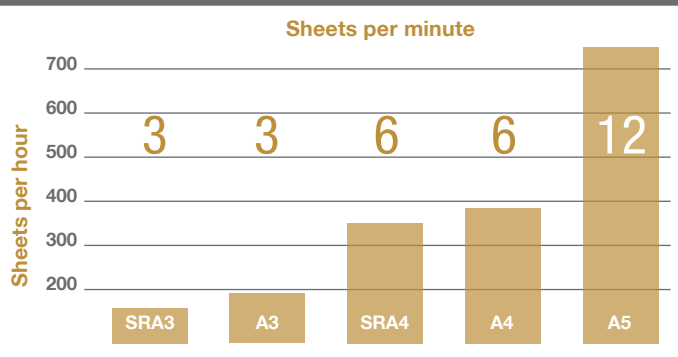

Laminates

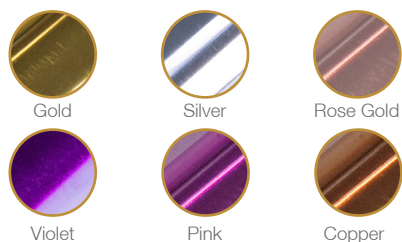

Foils and films

